



**CF port, fixed port,
rotatable, with thread,
stainless steel 304L,
DN 63 CF**



PFEIFFER 

CF port



Illustration only

CF port, fixed port, rotatable, with thread, stainless steel 304L, DN 63 CF

Dimensions

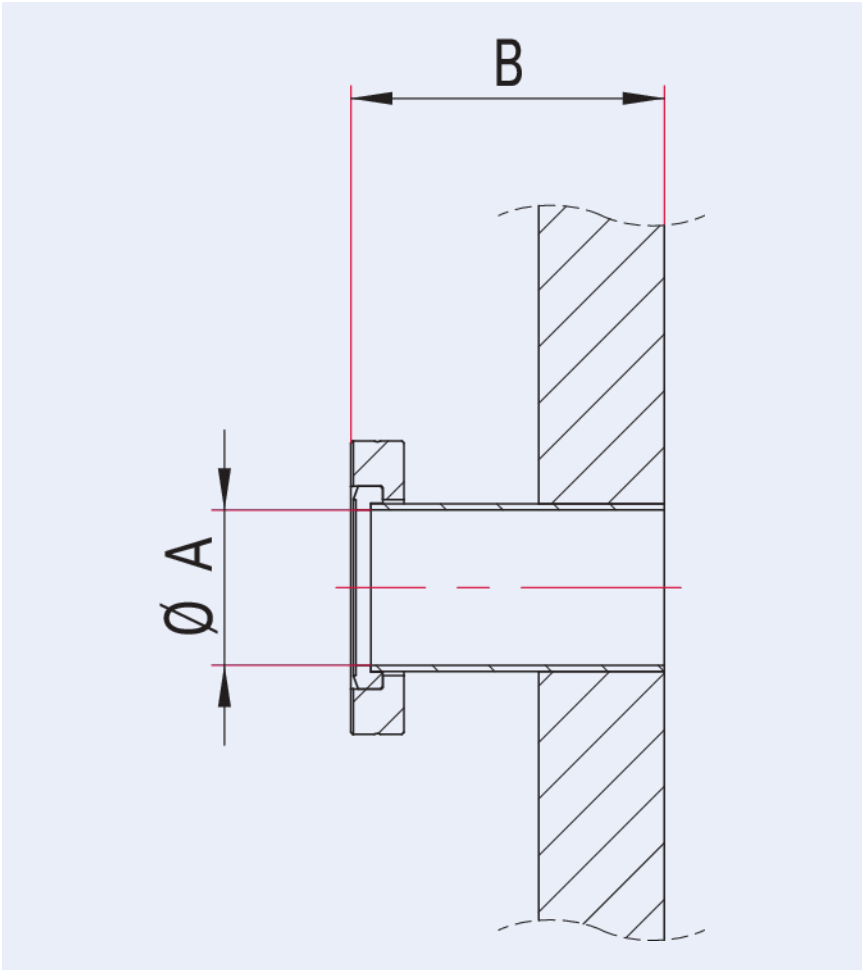

A | 66 mm

Technical Data	CF port, fixed port, rotatable, with thread, stainless steel 304L, DN 63 CF
Materials in contact with media	Stainless steel (AISI 304L)
Temperature range	196 – 300 °C
Connection flange	DN 63 CF
Pressure range	$1 \cdot 10^{-12}$ hPa – to ambient pressure
Temperature range max.	300 °C 572 °F 573.15 K
Temperature range min.	196 °C 320.8 °F 77.15 K

Order number	CF port, fixed port, rotatable, with thread, stainless steel 304L, DN 63 CF
CF port, fixed port, rotatable, with thread, stainless steel 304L, DN 63 CF	820KPD063-G



Errors and/or changes excepted. - 5/14/2025

Are you looking for an optimum vacuum solution?

Talk to us:

Pfeiffer Vacuum Components & Solutions GmbH Germany

T +49 551 99963-0

info-cs@pfeiffer-vacuum.com

Or scan the barcode, to visit our web page:



<https://webportal.pfeiffer-vacuum.com/global/en/contact>

Follow Us On Social Media

#pfeiffervacuum



www.pfeiffer-vacuum.com

PFEIFFER 