



**Welded flange ring,
stainless steel
316L/1.4404,
DN 160 ISO-K, 159 mm**



PFEIFFER 

Welding flange ring with weld lip

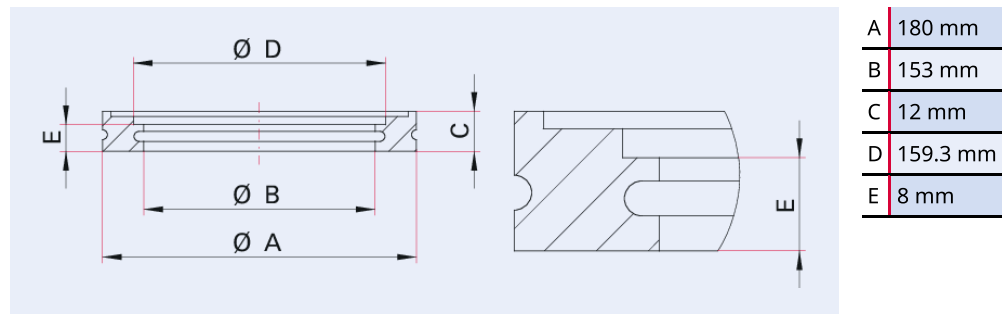

Illustration only

Welded flange ring, stainless steel 316L/1.4404, DN 160 ISO-K, 159 mm

- Version with weld lip

Dimensions



Technical Data

	Welded flange ring, stainless steel 316L/1.4404, DN 160 ISO-K, 159 mm
Materials in contact with media	Stainless steel 1,4404 (AISI 316L)
Pipe dimension	159 mm × 3 mm
Temperature range	196 – 350 °C
Connection flange	DN 160 ISO-K
Pressure range	1 · 10 ⁻⁸ hPa – 1.5 · 10 ³ hPa over pressure (elastomer seal); 1 · 10 ⁻⁹ hPa – 1.5 · 10 ³ hPa over pressure (metal seal)
Temperature range max.	350 °C 662 °F 623.15 K
Temperature range min.	196 °C 320.8 °F 77.15 K

Order number

	Welded flange ring, stainless steel 316L/1.4404, DN 160 ISO-K, 159 mm
Welded flange ring, stainless steel 316L/1.4404, DN 160 ISO-K, 159 mm	370FAN160-159-S



Errors and/or changes excepted. - 5/14/2025

Are you looking for an optimum vacuum solution?

Talk to us:

Pfeiffer Vacuum Components & Solutions GmbH Germany

T +49 551 99963-0

info-cs@pfeiffer-vacuum.com

Or scan the barcode, to visit our web page:



<https://webportal.pfeiffer-vacuum.com/global/en/contact>

Follow Us On Social Media

#pfeiffervacuum



www.pfeiffer-vacuum.com

PFEIFFER 