

Modular chamber, base plate, DN 400

PFEIFFER 

Modular chamber

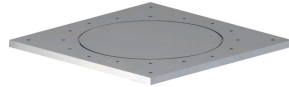
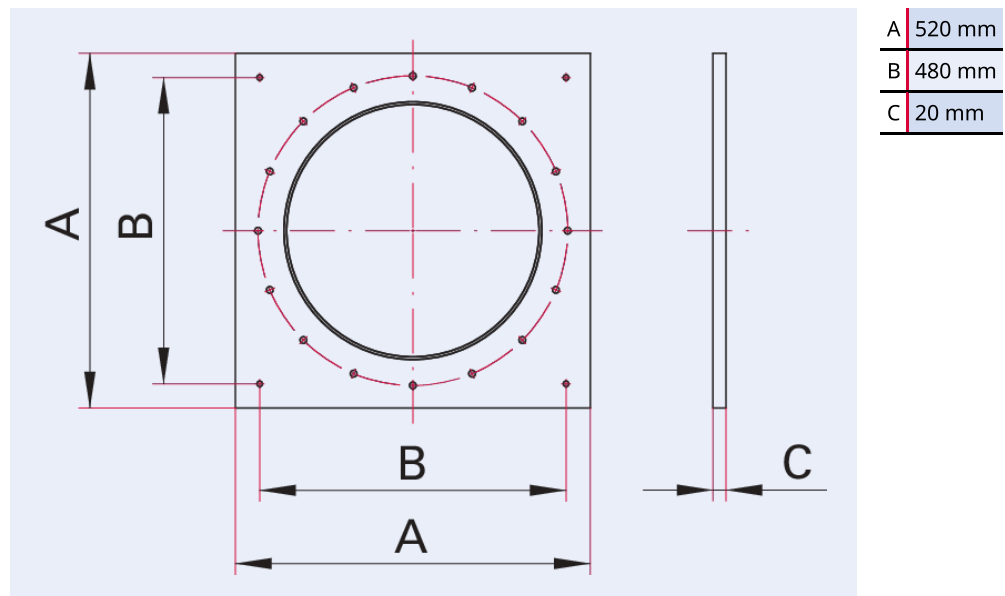

Illustration only

Modular chamber, base plate, DN 400

- Modular design for maximum flexibility at any time
- Square base plate with centering groove and sealing surface for an ISO-K centering ring and bolt circle with threaded holes for ISO-K claw clamps
- Fixing holes for mounting
- Ground surface

Dimensions



Technical Data	Modular chamber, base plate, DN 400
Materials in contact with media	Stainless steel 1.4301 (AISI 304)
Temperature range	15 – 150 °C
Tightness	$1 \cdot 10^{-9}$ Pa m ³ /s $7.5 \cdot 10^{-9}$ Torr l/s $1 \cdot 10^{-8}$ mbar l/s
Connection flange	DN 400 ISO-K
Pressure range	$1 \cdot 10^{-7}$ hPa – $5 \cdot 10^2$ hPa over pressure
Temperature range max.	150 °C 302 °F 423.15 K
Temperature range min.	15 °C 5 °F 258.15 K

Order number	Modular chamber, base plate, DN 400
Modular chamber, base plate, DN 400	820KMB400



Errors and/or changes excepted. - 5/14/2025

Are you looking for an optimum vacuum solution?

Talk to us:

Pfeiffer Vacuum Components & Solutions GmbH Germany

T +49 551 99963-0

info-cs@pfeiffer-vacuum.com

Or scan the barcode, to visit our web page:



<https://webportal.pfeiffer-vacuum.com/global/en/contact>

Follow Us On Social Media

#pfeiffervacuum



www.pfeiffer-vacuum.com

PFEIFFER 