



Elbow fitting, stainless steel 304L, DN 63 CF



PFEIFFER 

Elbow fitting

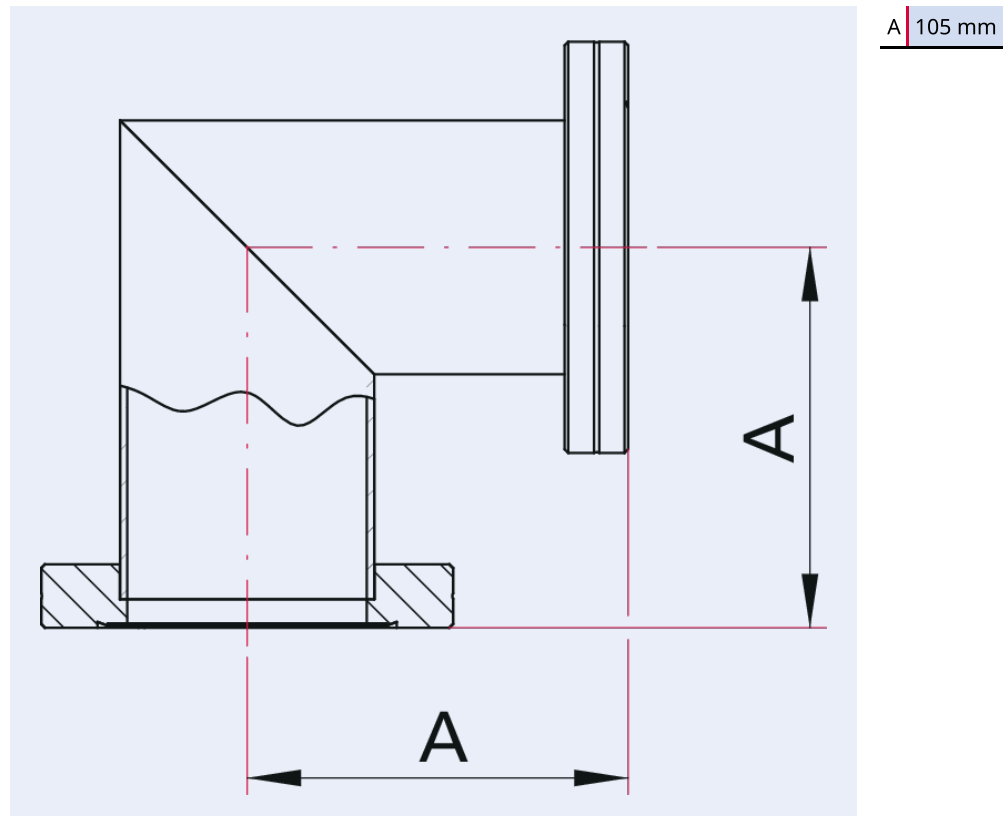

Illustration only

Elbow fitting, stainless steel 304L, DN 63 CF

- One end fixed, one end rotatable
- Pipe surface: glass-bead blasted (polished version on request)
- Other flange and tube materials on request

Dimensions



Technical Data	Elbow fitting, stainless steel 304L, DN 63 CF
Temperature range	196 – 300 °C
Tightness	1 · 10 ⁻¹¹ Pa m ³ /s 7.5 · 10 ⁻¹¹ Torr l/s 1 · 10 ⁻¹⁰ mbar l/s
Connection flange	DN 63 CF
Pressure range	1 · 10 ⁻¹² hPa – to ambient pressure
Material	Flange: stainless steel 304L; tube: stainless steel 304L or better
Temperature range max.	300 °C 572 °F 573.15 K
Temperature range min.	196 °C 320.8 °F 77.15 K

Order number	Elbow fitting, stainless steel 304L, DN 63 CF
Elbow fitting, stainless steel 304L, DN 63 CF	420RWS063-90



Errors and/or changes excepted. - 5/14/2025

Are you looking for an optimum vacuum solution?
Talk to us:
Pfeiffer Vacuum Components & Solutions GmbH Germany
T +49 551 99963-0
info-cs@pfeiffer-vacuum.com

Or scan the barcode, to visit our web page:



<https://webportal.pfeiffer-vacuum.com/global/en/contact>

Follow Us On Social Media
#pfeiffervacuum



www.pfeiffer-vacuum.com

PFEIFFER 