



**Anschweißflanschring,  
Edelstahl 1.4404/316L,  
DN 100 ISO-K, 2.1 mm**

---



**PFEIFFER** 

# Anschweißflanschring

PFEIFFER 



Abbildung ähnlich

**Anschweißflanschring, Edelstahl 1.4404/316L, DN 100 ISO-K, 2.1 mm**

## Maßbild

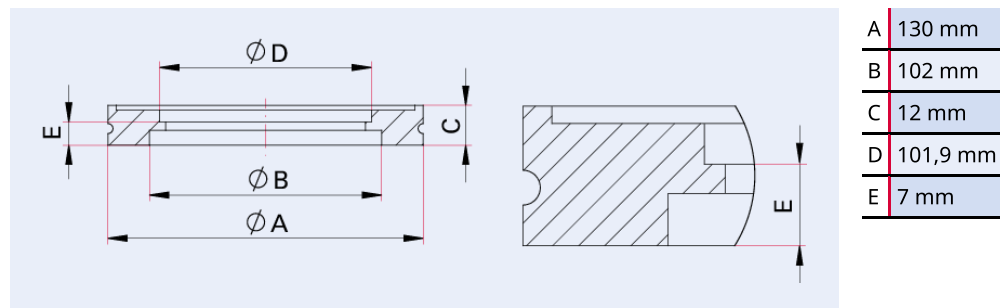

Technische Daten	Anschweißflanschring, Edelstahl 1.4404/316L, DN 100 ISO-K, 2.1 mm
Materialien mit Medienkontakt	Edelstahl 1.4404 (AISI 316L)
Rohrmaß	101,6 mm × 2,1 mm
Temperaturbereich	196 – 350 °C
Anschlussflansch	DN 100 ISO-K
Druckbereich	1 · 10 <sup>-8</sup> hPa – 1,5 · 10 <sup>3</sup> hPa Überdruck (Elastomerdichtung); 1 · 10 <sup>-9</sup> hPa – 1,5 · 10 <sup>3</sup> hPa Überdruck (Metalldichtung)
Temperaturbereich max.	350 °C   662 °F   623,15 K
Temperaturbereich min.	196 °C   320,8 °F   77,15 K

Bestellnummer	Anschweißflanschring, Edelstahl 1.4404/316L, DN 100 ISO-K, 2.1 mm
Anschweißflanschring, Edelstahl 1.4404/316L, DN 100 ISO-K, 2.1 mm	370FAN100-101

**Sie suchen eine optimale Vakuumlösung?  
Sprechen Sie uns an:**

**Pfeiffer Vacuum Components & Solutions GmbH Germany  
T +49 551 99963-0  
info-cs@pfeiffer-vacuum.com**

**Oder scannen Sie den Barcode, um unsere Webseite zu besuchen:**



[https://vacuum-shop.com/shop/de\\_DE/](https://vacuum-shop.com/shop/de_DE/)



Irrtümer und/oder Änderungen vorbehalten. - 14.05.2025

**Folgen Sie uns auf Social Media  
#pfeiffervacuum**



[www.pfeiffer-vacuum.com](http://www.pfeiffer-vacuum.com)

**PFEIFFER** 