



**Adapter, 304/1.4301
stainless steel, CF
flange: 304L, DN 16 CF /
DN 40 ISO-KF**

PFEIFFER 

Adapter

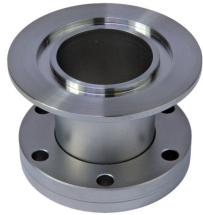
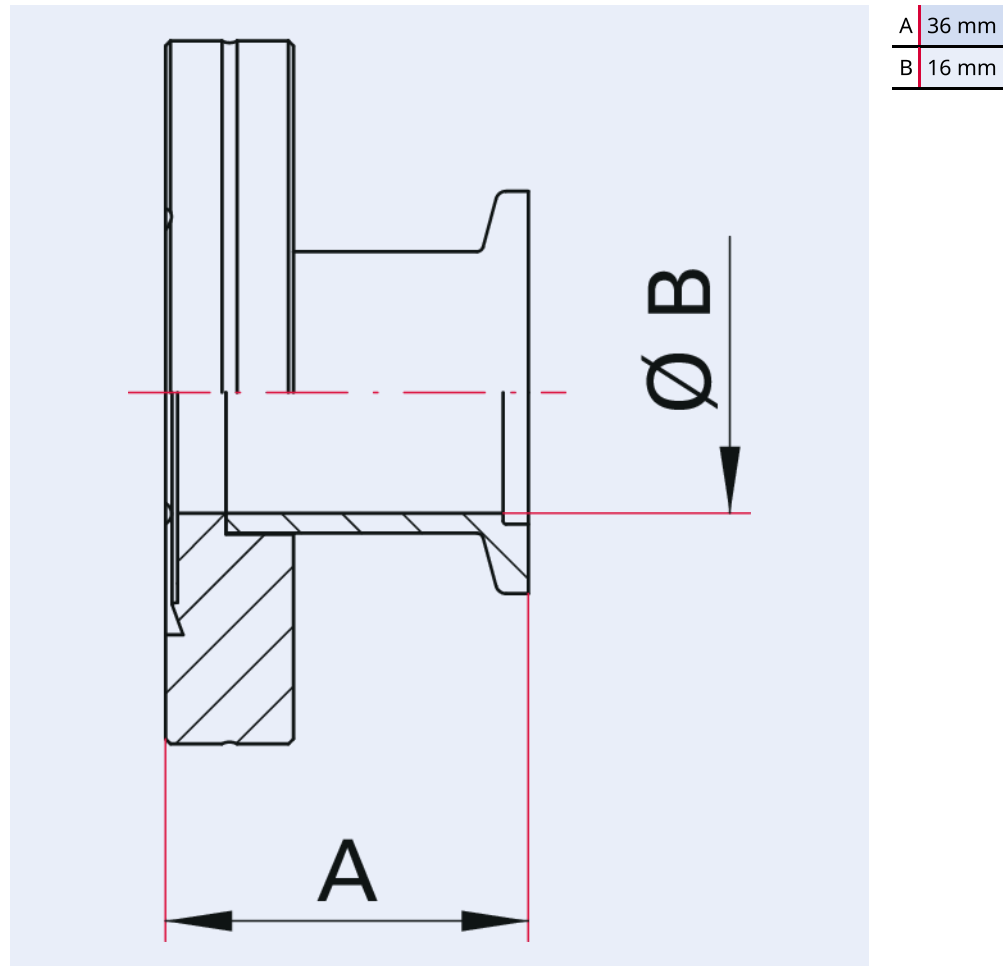

Illustration only

Adapter, 304/1.4301 stainless steel, CF flange: 304L, DN 16 CF / DN 40 ISO-KF

- Other nominal diameters and dimensions on request

Dimensions



Technical Data	Adapter, 304/1.4301 stainless steel, CF flange: 304L, DN 16 CF / DN 40 ISO-KF
Materials in contact with media	Stainless steel 1.4301/304, CF flange 304L
Nominal diameter reduced	DN 40 ISO-KF
Temperature range	196 – 300 °C
Connection flange	DN 16 CF / DN 40 ISO-KF
Pressure range	1 · 10 ⁻⁸ hPa – over pressure (elastomer seal); 1 · 10 ⁻⁹ hPa – over pressure (metal seal)
Temperature range max.	300 °C 572 °F 573.15 K
Temperature range min.	196 °C 320.8 °F 77.15 K

Order number	Adapter, 304/1.4301 stainless steel, CF flange: 304L, DN 16 CF / DN 40 ISO-KF
Adapter, 304/1.4301 stainless steel, CF flange: 304L, DN 16 CF / DN 40 ISO-KF	420RUG016-040-36



Errors and/or changes excepted. - 5/14/2025

Are you looking for an optimum vacuum solution?

Talk to us:

Pfeiffer Vacuum Components & Solutions GmbH Germany

T +49 551 99963-0

info-cs@pfeiffer-vacuum.com

Or scan the barcode, to visit our web page:



<https://webportal.pfeiffer-vacuum.com/global/en/contact>

Follow Us On Social Media

#pfeiffervacuum



www.pfeiffer-vacuum.com

PFEIFFER 