



**Welding flange,
rotatable, stainless
steel 304L, DN 160 CF,
2.4 mm**



PFEIFFER 

Welding flange, rotatable



Illustration only

Welding flange, rotatable, stainless steel 304L, DN 160 CF, 2.4 mm

Dimensions

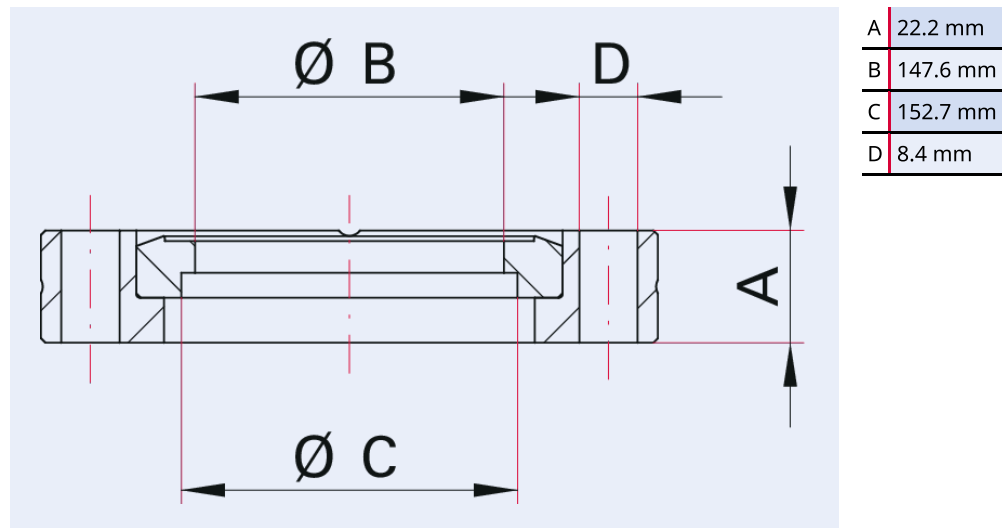

Technical Data

Welding flange, rotatable, stainless steel 304L, DN 160 CF, 2.4 mm

Materials in contact with media	Stainless steel (AISI 304L)
Number of screws	20 Pieces
Pipe dimension	152.4 mm × 2.4 mm
Temperature range	196 – 300 °C
Connection flange	DN 160 CF
Pressure range	$1 \cdot 10^{-12}$ hPa – to ambient pressure
Temperature range max.	300 °C 572 °F 573.15 K
Temperature range min.	196 °C 320.8 °F 77.15 K

Order number	Welding flange, rotatable, stainless steel 304L, DN 160 CF, 2.4 mm
Welding flange, rotatable, stainless steel 304L, DN 160 CF, 2.4 mm	420FAD160-152



Errors and/or changes excepted. - 5/14/2025

Are you looking for an optimum vacuum solution?

Talk to us:

Pfeiffer Vacuum Components & Solutions GmbH Germany

T +49 551 99963-0

info-cs@pfeiffer-vacuum.com

Or scan the barcode, to visit our web page:



<https://webportal.pfeiffer-vacuum.com/global/en/contact>

Follow Us On Social Media

#pfeiffervacuum



www.pfeiffer-vacuum.com

PFEIFFER 